

REV.	DESCRIPTION	DATE

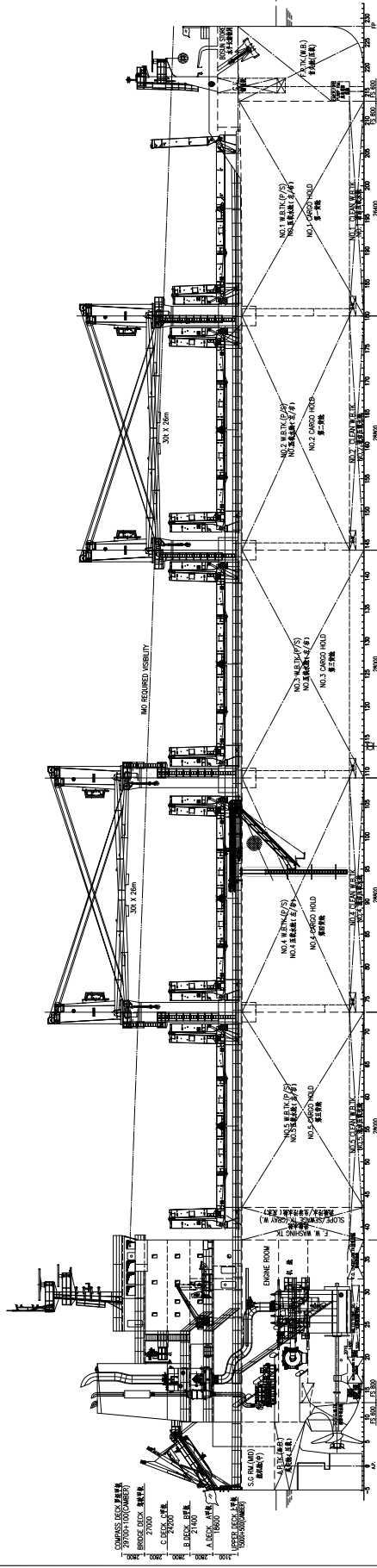
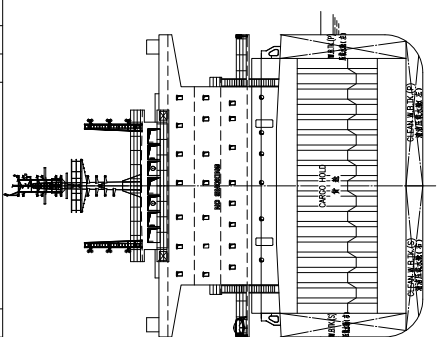

ER UPPER PLATFORM
上層平台 BL10500

A DECK (8P)
A甲板

B DECK (8P)
B甲板

C DECK (8P)
C甲板

BRIDGE DECK
駕駛台甲板

COMPASS DECK
羅經台甲板

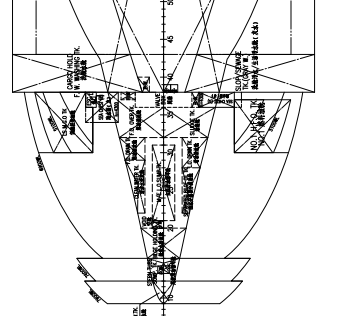
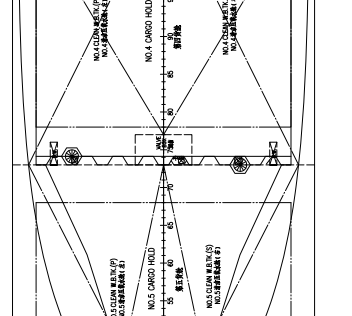
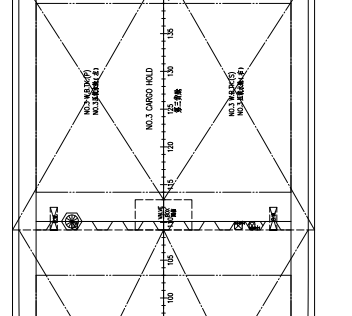
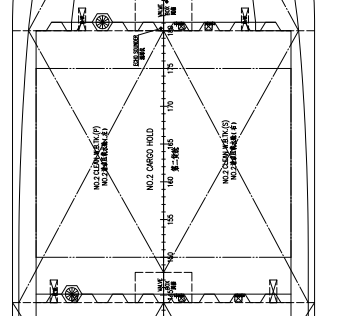
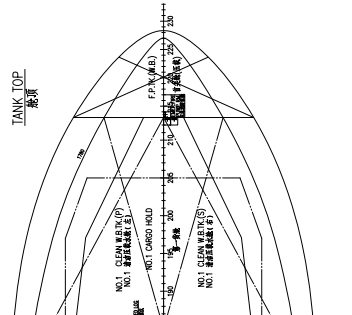
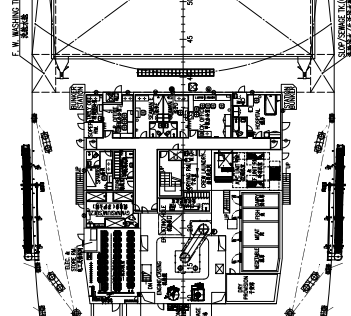
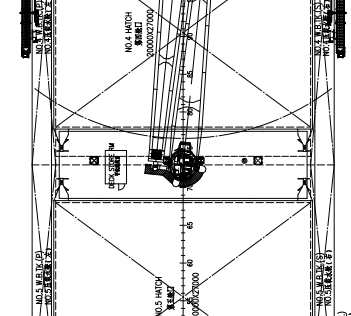
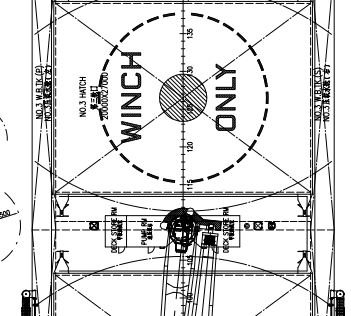
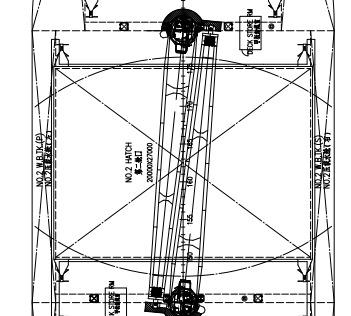
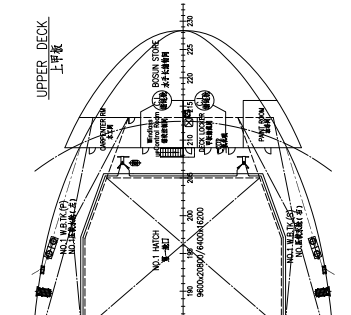
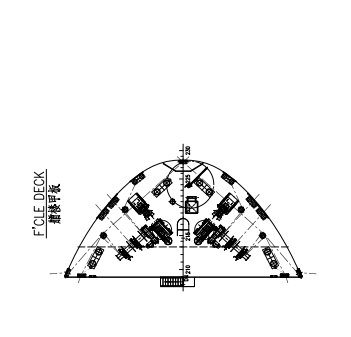
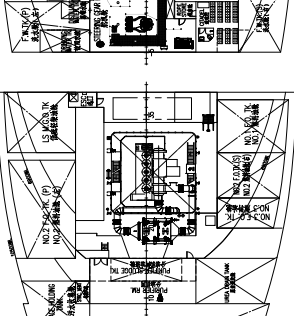
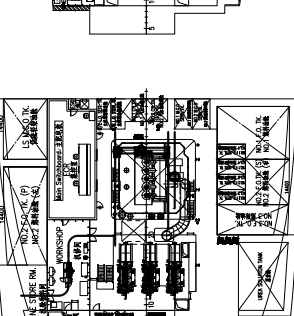
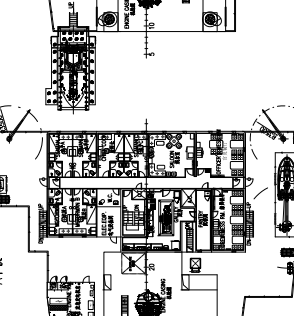
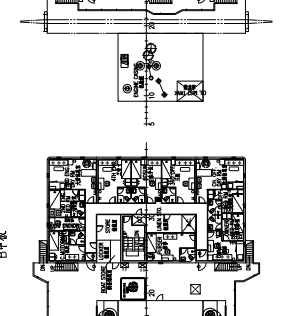
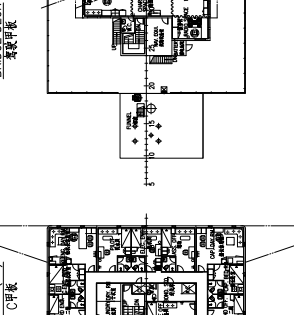
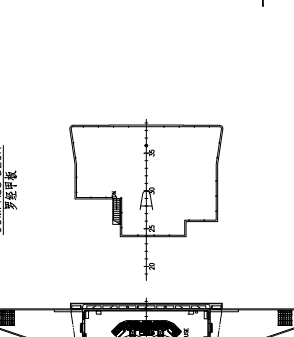

CP-110-18825

DATE

COMPASS DECK 羅經台
BRIDGE DECK 駕駛台
C. DECK 8P
B. DECK 8P
A. DECK 8P
UPPER PLATFORM 上層平台

NO. 1 CLEAN WASTE (P)
NO. 2 CLEAN WASTE (P)
NO. 3 CLEAN WASTE (P)
NO. 4 CLEAN WASTE (P)
NO. 5 CLEAN WASTE (P)
NO. 6 CLEAN WASTE (P)
NO. 7 CLEAN WASTE (P)
NO. 8 CLEAN WASTE (P)
NO. 9 CLEAN WASTE (P)
NO. 10 CLEAN WASTE (P)

NO. 1 WASTE (P)
NO. 2 WASTE (P)
NO. 3 WASTE (P)
NO. 4 WASTE (P)
NO. 5 WASTE (P)
NO. 6 WASTE (P)
NO. 7 WASTE (P)
NO. 8 WASTE (P)
NO. 9 WASTE (P)
NO. 10 WASTE (P)

NO. 1 WASTE (P)
NO. 2 WASTE (P)
NO. 3 WASTE (P)
NO. 4 WASTE (P)
NO. 5 WASTE (P)
NO. 6 WASTE (P)
NO. 7 WASTE (P)
NO. 8 WASTE (P)
NO. 9 WASTE (P)
NO. 10 WASTE (P)

NO. 1 WASTE (P)
NO. 2 WASTE (P)
NO. 3 WASTE (P)
NO. 4 WASTE (P)
NO. 5 WASTE (P)
NO. 6 WASTE (P)
NO. 7 WASTE (P)
NO. 8 WASTE (P)
NO. 9 WASTE (P)
NO. 10 WASTE (P)

NO. 1 WASTE (P)
NO. 2 WASTE (P)
NO. 3 WASTE (P)
NO. 4 WASTE (P)
NO. 5 WASTE (P)
NO. 6 WASTE (P)
NO. 7 WASTE (P)
NO. 8 WASTE (P)
NO. 9 WASTE (P)
NO. 10 WASTE (P)

NO. 1 WASTE (P)
NO. 2 WASTE (P)
NO. 3 WASTE (P)
NO. 4 WASTE (P)
NO. 5 WASTE (P)
NO. 6 WASTE (P)
NO. 7 WASTE (P)
NO. 8 WASTE (P)
NO. 9 WASTE (P)
NO. 10 WASTE (P)

DATE

DATE

DATE

DATE

DATE

DATE

DATE

DATE